

**Pump Assembly**

**Intake Hose Assembly**

**Discharge Hose Assembly**

**Filter Screen Assembly**

**Riser Tube Assembly**

**Motor Assembly**

**ARM - 60, 90, 120 Tank Assembly**

**ARMADILLO COOKING OIL FILTRATION MACHINES**



Model:	ARM-60	\$2,435
	ARM-90	\$2,530
	ARM-120	\$2,790
Capacity:	ARM-60	60#
	ARM-90	90#
	ARM-120	120#
Motor:	1/3 HP, 120v - 60 cycle Thermal Overload Reset	
Pump:	8 GPM Pump	

11/29/2019



[OrderDesk@OilSolutionsGroup.com](mailto:OrderDesk@OilSolutionsGroup.com)







**\*\*\* Major Assemblies \*\*\***

Part Name	Description	MSRP
 <p><b>\$689.00</b> 16"x16"x11" Tank+Casters-60</p>	 <p><b>\$698.00</b> 26"x16"x11" Tank+Casters-90</p>	 <p><b>\$725.00</b> 28"x18"x11" Tank+Casters-120</p>
<p>Stainless Steel Tank designed for filtering hot cooking oils. Tank includes two fixed casters and two swivel casters for easy maneuverability and removable push handle with convenient power cord wrap.</p> <p><b>By Size</b></p> <p><i>PART#: TANK + CASTERS ASSEMBLY</i></p>		

	<p><b>Pump Assembly</b></p> <p>(Top exposed portion of the photo at left.) Viking 8 gallon per minute non-shear pump for heavy duty hot oil movement. Pump is plumbed for quick-disconnect fittings to simply attach intake and discharge hoses. Discharge is fitted with valved shut-off nipple for safety.</p> <p><i>PART #: PUMP-TURBOASSY</i></p>	<p><b>\$340.00</b></p>
	<p><b>Motor Assembly</b></p> <p>Stainless Steel MOTOR ASSEMBLY. 1/3 HP Viking electric motor is covered with Stainless Steel shroud for protection. Easily removable back plate has cooling louvers and provides easy access to electrical components. Reset switch on bottom. Includes 10' extension cord.</p> <p><i>PART #: MOTOR Only ASSY-NSF</i></p>	<p><b>\$698.00</b></p>
<p><b>PUMP and MOTOR ASSEMBLY</b> - Combination of PUMP ASSEMBLY and MOTOR ONLY ASSEMBLY shipped as an assembled unit</p>		<p><b>\$998.00</b></p> <p><i>MOTOR-PUMPASSY</i></p>

## ARMADILLO (all machines) - TANK ASSEMBLY

Description	Description	Description
 <p><b>ARM-60 TANK</b> only - Stainless Steel - Capacity 120# hot cooking oil (recommended 55#) - Permanent corner wand holders - Overall measurements of tank 16" x 16" x 10" - welded gussets for installation of push handle. Angled upper rim to function as splash guard for safety.</p> <p><b>\$578.95</b></p> <p><i>PART #: X-TANK-60#</i></p>	 <p><b>ARM-90 TANK</b> only - Stainless Steel - Capacity 90# hot cooking oil (recommended 80#) - Permanent corner wand holders - Overall measurements of tank 26" x 16" x 10" - welded gussets for installation of push handle. Angled upper rim to function as splash guard for safety.</p> <p><b>\$606.00</b></p> <p><i>PART #: X-TANK-90#</i></p>	 <p><b>ARM-120 TANK</b> only - Stainless Steel - Capacity 120# hot cooking oil (recommended 110#) - Permanent corner wand holders - Overall measurements of tank 28" x 18" x 10" - welded gussets for installation of push handle. Angled upper rim to function as splash guard for safety.</p> <p><b>\$626.00</b></p> <p><i>PART #: X-TANK-120#</i></p>

COMPONENTS:			COMPONENTS:		
Photo	Description	Price	Photo	Description	Price
 <p><b>SWIVEL CASTER</b> - Single 3" Thermoplastic Rubber Swivel Caster with Top Plate 1.75 x 2.625 by Durable Casters (two per tank)</p> <p><b>\$11.50</b></p> <p><i>PART #: X-CASTER-Swivel</i></p>	 <p><b>TANK PUSH HANDLE</b> - constructed of 1" Stainless Steel Tube for strength and stability - 1" Stainless Steel Tube cross-bar designed to provide opening to control and support discharge hose - convenient stainless steel rod extension cord keeps constructed of 1/4" stainless rod</p> <p><b>\$112.00</b></p> <p><i>PART #: PUSH HANDLE Assy</i></p>				
 <p><b>FIXED CASTER</b> - Single 3" Thermoplastic Rubber Fixed Caster with Top Plate 1.75 x 2.625 by Durable Casters (two per tank)</p> <p><b>\$11.50</b></p> <p><i>PART #: X-CASTER-Fixed</i></p>	 <p><b>RIBBED PLUGS</b> - used to seal the open end of the PUSH HANDLE - temperature resistant polyethylene (two per handle)</p> <p><b>\$0.78</b></p> <p><i>PART #: X-PLUG-Ribbed</i></p>				
 <p><b>CASTER KIT</b> - Durable caster replacement package for Armadillo oil filtration tank. (2) 3" fixed casters, (2) 3" swivel casters, (16) 1/4"-20 bolts, and (16) 1/4"-20 nuts included.</p> <p><b>\$37.75</b></p> <p><i>PART #: CASTER KIT ASSEMBLY</i></p>	 <p><b>LOCK NUT</b> - for securing caster mounting bolts - Stainless steel with nylon insert, 1/4"-20 (sixteen nuts per tank)</p> <p><b>\$0.25</b></p> <p><i>PART #: X-LOCKNUT-Caster</i></p>				
	 <p><b>HEX BOLT</b> - for mounting Casters to Tank - Stainless steel 18- 8, 1/4"-20 x 1/2" (sixteen bolts per tank)</p> <p><b>\$0.25</b></p> <p><i>PART #: X-BOLT-Caster</i></p>				

**ARMADILLO (all Armadillo machines) - MOTOR ASSEMBLY**

Photo	Description	Price
-------	-------------	-------



**MOTOR ONLY ASSEMBLY** - Stainless Steel MOTOR ASSEMBLY. 1/3 HP Viking electric motor is covered with Stainless Steel shroud for protection. Easily removable back plate has cooling louvers and provides easy access to electrical components. Reset switch on bottom. **NSF Certified.** This Motor Assembly will fit all ARMADILLO Filter Machine models.

**\$698.00**

**PART #: MOTOR Only ASSY**

**MOTOR SHROUD** – Stainless Steel cover and protect Electric Motor and electrical harness

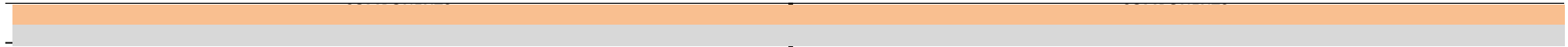

**VIKING ELECTRIC MOTOR** - 1/3 HP 120v motor designed to operate with HAIGHT PUMP. 1750 RPM reversible, able to be rewired to operate on 220volt operations.

**\$379.00**

**PART #: X-MOTORonly-TURBO**



**MOTOR SHROUD** - Stainless Steel to cover and protect Electric Motor and electrical harness.

**\$129.00**

**PART #: X-SHROUD-SMI**



**BASE PLATE / MOTOR MOUNT** - for mounting Electric Motor. Incorporates a built in hanger designed to allow easy and secure attachment to the lip of the hot oil Tank.

**\$183.00**

**PART #: X-BASEPLATE-SMI**



**BACK PLATE** - Stainless Steel - attaches by six screws to the back of the motor Shroud. Easily removable to access electrical components.

**\$47.00**

**PART #: X-BACK PLATE-SMI**



**BOTTOM PLATE** - Stainless Steel - slides into the bottom of the Base Plate and provides protection to the bottom of the motor. Bottom Plate easily slides out in order to give access to the motor reset switch.

**\$27.00**

**PART #: X-BOTTOM PLATE-SMI**



**SWITCH GUARD** - Heavy Guage Stainless Steel - protects the Toggle Switch from damage and accidental actuation.

**\$7.75**

**PART #: X-SWITCHGUARD-SMI**















**Extension Cord** - Heavy Guage SWOJJ Oil and Water resistant 10 foot extension cord

**\$28.75**









**PART #: X-CORD-10EXT**

**ARMADILLO (all Armadillo machines) - MOTOR ASSEMBLY Cont.**



Photo	Description	Price	Photo	Description	Price
	<b>PLUG WIRE ASSEMBLY</b> - 14 gauge - 3 wire - SJEOOW - 17" power cord with molded 5-15 NEMA Male Plug. Quick Connect terminals are provided for simple connection inside the shroud. <i>PART #: X-CORD-Power-NSF</i>	<b>\$18.75</b>		<b>TOGGLE SWITCH</b> - Heavy Duty - CARLING Switch will handle up to 20amps and is designed to control 120 volt electric motors up to 1 1/2" HP. <i>PART #: X-SWITCH-ToggleHD</i>	<b>\$8.96</b>
	Nylon <b>KELLEM</b> with nylon <b>STRAIN RELIEF</b> guard for protection of the Power Cord. Kellem firmly grips the power cord to hold it in place. <i>PART #: X-KELLEM-StrainRelief</i> <b>NYLON LOCKNUT</b> - secures the Kellem and Strain Relief firmly on the Stainless Steel Shroud. <i>PART #: X-LOCKNUT-Nylon</i>	<b>\$9.00</b> <b>\$0.98</b>		<b>RUBBER SWITCH BOOT</b> - Covers and protects the toggle switch for extra long life and clean operation. <i>PART #: X-SWITCHBOOT</i>	<b>\$3.50</b>
	<b>PLUG WIRE Power Cord ASSEMBLY</b> - 14 gauge - 3 wire - SJEOOW - 17" power cord with molded 5-15 NEMA Male Plug. Quick Connect terminals are provided for simple connection inside the shroud. With nylon <b>KELLEM</b> with nylon <b>STRAIN RELIEF</b> guard for protection of the Power Cord. And, Nylon Nut. <i>PART #: Cord-PowerASSY</i>	<b>\$29.25</b>		<b>MOTOR WIRE ASSEMBLY</b> - 14 gauge - 3 wire - SJEOOW - 17" cord. One end of cord has metal detent ring and pre-stripped wires for easy connection inside motor electrical box. Quick Connect terminals are provided at the other end for simple connection to Power Cord and Toggle Switch inside the shroud. <i>PART #: X-CORD-Motor-NSF</i>	<b>\$18.75</b>
	<b>CARRIAGE BOLT</b> - used to mount the electric Motor to the Base Plate. Stainless Steel 18-8, 5/16"-18 x 3/4" long. <i>PART #: X-BOLT-Motor</i>	<b>\$0.38</b>		<b>SHROUD SCREWS</b> - Stainless Steel used to attach Shroud and Back Plate to the Base Plate. Pan Head Machine Screw - Phillips Head - #10-32 x 1/4" <i>PART #: X-SCREW-Shroud</i>	<b>\$0.15</b>
	<b>FLAT WASHER</b> - Stainless Steel used in attaching the electric Motor to the Base Plate - 5/16" <i>PART #: X-WASHER-Flat</i>	<b>\$0.08</b>		<b>LOCK NUT</b> - Stainless Steel nut used to secure Carriage Bolt in the electric Motor mount assembly. Hex - nylon insert to provide vibration protection - 5/16"-18. <i>PART #: X-LOCKNUT-Motor</i>	<b>\$0.25</b>
	<b>LOCK WASHER / SPLIT WASHER</b> - Stainless Steel used to secure the electric Motor to the Base Plate - 5/16" <i>PART #: X-WASHER-SplitLock</i>	<b>\$0.09</b>		<b>Nameplate/ Switch GuardScrews</b> -Stainless Steel used to attach Shroud and Back Plate to the Base Plate. Pan Head Machine Screw -Phillips Head -#6-32 x 1/4" <i>PART #: X-SCREW-Nameplate-Truss</i>	<b>\$0.35</b>





**ARMADILLO (all Armadillo machines) - PUMP ASSEMBLY**

Photo	Description	Price
	<p><b>PUMP ASSEMBLY</b> - Viking 8 gallon per minute non-shear pump for heavy duty hot oil movement. Pump is plumbed for quick-disconnect fittings to simply attach intake and discharge hoses. Discharge side is fitted with valved shut-off nipple that will close flow of oil if the hose is disconnected, or improperly connected. Convenient handle for lifting motor assembly. Pump Assembly fits all ARMADILLO Filter Machines.</p> <p><i>PART #: PUMP-TURBOASSY</i></p>	<b>\$340.00</b>

COMPONENTS:			COMPONENTS:		
Photo	Description	Price	Photo	Description	Price
	<p><b>PUMP</b> - Viking 8 gallon per minute non-shear pump designed for heavy-duty hot oil movement. Pump is extremely efficient, low amp-draw, debris tolerant, and has no bearings to fail.</p> <p><i>PART #: X-PUMP-8gpm-TURBO</i></p>	<b>\$199.00</b>		<p><b>PUMP HANDLE</b> - Stainless Steel - Convenient handle to lift the Motor/Pump Assembly.</p> <p><i>PART #: X-HANDLE-Pump-SMI</i></p>	<b>\$48.10</b>
	<p><b>BUSHING</b> - Stainless Steel - reduces pump ports from 3/4" to 1/2" for the 1/2" fittings.</p> <p><i>PART #: X-BUSHING-3/4"to1/2"</i></p>	<b>\$9.25</b>		<p><b>QUICK-DISCONNECT Suction NIPPLE CAM STYLE</b>- Stainless Steel cam-style NIPPLE on intake side of pump allows for the easy attachment of the intake hose.</p> <p><i>PART #: X-NIPPLE-Cam</i></p>	<b>\$32.95</b>
	<p><b>STREET ELBOW</b> - Stainless Steel 304 - 90 degree - 1/2" Threaded Fitting</p> <p><i>PART #: X-ELBOW-SS1/2</i></p>	<b>\$9.95</b>		<p><b>2" NIPPLE / PIPE</b> - Stainless Steel - Schedule 40 welded 304 Stainless Steel - 1/2" NPT threads on both ends.</p> <p><i>PART #: X-NIPPLE-1/2"X2"</i></p>	<b>\$9.95</b>
	<p><b>QUICK-DISCONNECT NIPPLE WITH SHUT-OFF</b> - SnapTite female with Shut-Off valved used on discharge side of pump. 1/2" NPT female threads - Electroless Nickel Plate</p> <p><i>PART #: X-NIPPLE-SO-NP</i></p>	<b>\$49.95</b>		<p><b>Gasket For Viking 8X Pump</b> - Gasket for external gear Haight pump</p> <p><i>PART #: X-GASKET-Turbo</i></p>	<b>\$2.75</b>

**ARMADILLO - ARM-120, 90, 60 INTAKE HOSE ASSEMBLIES**

Photo	Description	Price
	<b>INTAKE HOSE ASSEMBLY for ARM-120</b> - 13.75" - Silicone covered, stainless steel mesh reinforced hot oil hose with swivel fittings at both ends. Interior nylon inner liner is armored to resist collapsing under vacuum. Also fitted at both ends are quick disconnects for easy and safe cleaning and operation. O'All Length 15" <i>PART #: HOSE ASSY - INTAKE-120</i>	<b>\$179.00</b>
	<b>INTAKE HOSE ASSEMBLY for ARM-90</b> - 12.75" - Silicone covered, stainless steel mesh reinforced hot oil hose with swivel fittings at both ends. Interior nylon inner liner is armored to resist collapsing under vacuum. Also fitted at both ends are quick disconnects for easy and safe cleaning and operation. O'All Length 14" <i>PART #: HOSE ASSY - INTAKE-90</i>	<b>\$172.00</b>
	<b>INTAKE HOSE ASSEMBLY for ARM-60</b> - 7.75" - Silicone covered, stainless steel mesh reinforced hot oil hose with swivel fittings at both ends. Interior nylon inner liner is armored to resist collapsing under vacuum. Also fitted at both ends are quick disconnects for easy and safe cleaning and operation. O'All Length 10" <i>PART #: HOSE ASSY - INTAKE-60</i>	<b>\$169.00</b>

COMPONENTS:			COMPONENTS:		
Photo	Description	Price	Photo	Description	Price
<b>INTAKE HOSE for model ARM 120, 90, 60</b> - Silicone covered, stainless steel mesh reinforced hot oil hose. Swivel fittings at both ends. Interior nylon inner liner armored to resist collapsing under vacuum.					
	<b>ARM-120 Part # X-HOSE-IN-13.75"</b>	<b>\$69.50</b>		<b>STREET ELBOW</b> -Stainless Steel 304 - 1/2" Threaded 90 degree Fitting <i>PART #: X-ELBOW-SS-1/2</i>	<b>\$9.95</b>
	<b>ARM-90 Part # X-HOSE-IN-12.75"</b>	<b>\$63.50</b>			
	<b>ARM-60 Part # X-HOSE-IN-7.75"</b>	<b>\$62.50</b>			
	<b>QUICK-DISCONNECT COUPLER</b> - Cam Style - Stainless Steel Snap Lock straight through coupler. Easy to remove and very secure. Food Grade high-temperature Silicone gasket. 1/2" NPT female threads. <i>PART #: X-COUPLER-CamSS</i>	<b>\$34.00</b>		<b>QUICK-DISCONNECT COUPLER</b> - Electroless Nickel Plated with BLACK Nylon Bumper to insulate from heat and make the disconnect simple. This coupler is not valved. 1/2" NPT female threads. <i>PART #: COUPLER-PLAIN-BLACK</i>	<b>\$72.00</b>

**ARMADILLO - (ALL MACHINES) RISER TUBE ASSEMBLY**



Description	Cost
-------------	------



**RISER TUBE ASSEMBLY** - 8 inch stainless steel tube fitted with a nipple at one end to allow easy attachment of the Intake Hose Assembly and at the other end a large Knurled Fitting with ACME threads for easy connection to Filter Screen. This part fits all ARMADILLO Filter Machines.

**\$84.00**

*PART #:* **RISER TUBE ASSY**

COMPONENTS:			COMPONENTS:		
Photo	Description	Price	Photo	Description	Price
	<b>QUICK-DISCONNECT NIPPLE</b> - used to connect intake hose to Riser Tube - 1/2" NPT threaded female fitting (Electroless Nickel Plated). <i>PART #:</i> <b>X-NIPPLE-FNP</b>	<b>\$24.95</b>		<b>KNURLED KNOB</b> - Stainless Steel ACME threads for simple screw attachment to Filter Screen - 1/2" NPT threads to connect to Stainless Steel Pipe. <i>PART #:</i> <b>X-KNURLED CAP</b>	<b>\$45.00</b>
	<b>STAINLESS STEEL PIPE</b> - 8" schedule 40 welded stainless steel pipe threaded at both ends 1/2" NPT. <i>PART #:</i> <b>X-PIPE-1/2"X8"</b>	<b>\$29.50</b>			



**ARMADILLO - ARM-120 & ARM-90 FILTER SCREEN ASSEMBLY**

Description	Cost
-------------	------





**FILTER SCREEN ASSEMBLY - 90 AND 120 POUND FILTER TANKS.** Filter screen is a heavy gauge stainless steel "tubular slit" material with center mounted ACME threaded fitting. The filter is the re-usable Masterfily Fabric Filter that will give unmatched filtration for a full week (FDA APPROVED AND NSF CERTIFIED). Stainless Steel clip is included to hold filter snugly on the screen. **\$264.00**

**PART #: FILTER SCREEN-120 ASSY**

**FILTER SCREEN ASSEMBLY - 60 POUND FILTER TANK.** Filter screen is a heavy gauge stainless steel "tubular slit" material with center mounted ACME threaded fitting. The filter is the re-usable Masterfily Fabric Filter that will give unmatched filtration for a full week (FDA APPROVED AND NSF CERTIFIED). Stainless Steel clip is included to hold filter snugly on the screen. **\$259.00**

**PART #: FILTER SCREEN-60 ASSY**

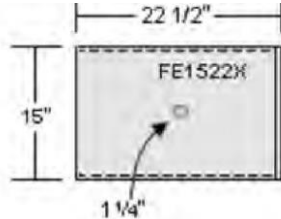
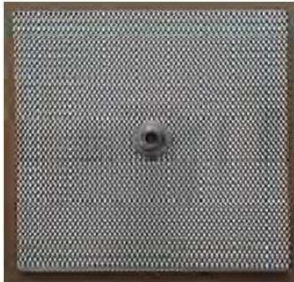
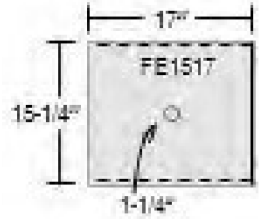
**COMPONENTS:**

Photo	Description	Price	Photo	Description	Price
	<p><b>For ARM 120 and ARM90</b></p> <p><b>FILTER SCREEN</b> - is heavy gauge stainless steel "tubular slit" material with center mounted ACME threaded fitting. The Filter Screen allows the Fabric Filter to realize its maximum efficiency and will draw virtually all residual oil from the basin.</p> <p><b>PART #: X-SCREEN-1522X</b></p>	<b>\$162.00</b>		<p><b>For ARM 120 and ARM 90</b></p> <p><b>FABRIC FILTER - FE1522X – 10-PACK- MASTERFIL</b></p> <p>Filter Screen above and allow filtration of hot cooking oil. Will filter down to 1/2 Micron on first pass through the material. FABRIC FILTER will double the oil life over standard paper filters.</p> <p><b>PART #: FE1522X-10</b></p>	<b>\$155.00</b>
	<p><b>For ARM 60</b></p> <p><b>FILTER SCREEN</b> - is heavy gauge stainless steel "tubular slit" material with center mounted ACME threaded fitting. The Filter Screen allows the Fabric Filter to realize its maximum efficiency and will draw virtually all residual oil from the basin.</p> <p><b>PART #: X-SCREEN-1517</b></p>	<b>\$149.00</b>		<p><b>For ARM60</b></p> <p><b>FABRIC FILTER - FE1517 – 10-PACK- MASTERFIL</b></p> <p>Filter Screen above and allow filtration of hot cooking oil. Will filter down to 1/2 Micron on first pass through the material. FABRIC FILTER will double the oil life over standard paper filters.</p> <p><b>PART #: FE1517-10</b></p>	<b>\$155.00</b>
				<p><b>14" CLIP</b> - 14" Stainless Steel Clip to hold filter firmly onto Filter Screen</p> <p><b>PART #: X-CLIP-14"</b></p> <p><b>12" CLIP</b> - 12" Stainless Steel Clip to hold filter firmly onto Filter Screen</p> <p><b>PART #: X-CLIP-12"</b></p>	<b>\$24.95</b> <b>\$15.95</b>

**ARMADILLO - (ALL MACHINES) DISCHARGE HOSE ASSEMBLY**



	Description	Cost
--	-------------	------







**DISCHARGE HOSE ASSEMBLY** - Five foot long Silicone, stainless steel mesh reinforced hot-oil hose with swivel fittings and protected by Sil-Braid and inner spring guard to relieve strain at the collars for long lasting use. Wand is stainless steel with cushioned, heat resisting rubber grip. Hose has Valved Quick-Disconnect fitting for easy connections and safety. This assembly fits all ARMADILLO Filter Machines.

**\$345.00**

*PART #:* **HOSE ASSY Discharge**

COMPONENTS:			COMPONENTS:		
Photo	Description	Price	Photo	Description	Price
	<p><b>KLEENFLO Silicone HOSE</b>- 61" White Silicone Cover - Stainless Steel Braid Mesh - PTFE inner Liner protected by inner spring guard -1/2" NPT stainless steel swivel fittings at each end - Silicone Braid Hose reinforcement at each 'collar' to reduce wear and increase life.</p> <p><i>PART #:</i> <b>X-HOSE-OUT-SB-SPRING</b></p>	<b>\$162.75</b>		<p><b>QUICK-DISCONNECT COUPLER</b> -with automatic Shut-Off Valve - Snap-Tite H Series Valved Coupler, 1/2" NPT - Viton seals - BLUE Nylon Bumper - Electroless Nickel Plate.</p> <p><i>PART #:</i> <b>COUPLER-SO-BLUE</b></p>	<b>\$92.00</b>
	<p><b>WAND</b> - Stainless Steel - Rubber Cushion/ Heat Shield Grip - 1/2" NPT thread fitting for attachement to hose.</p> <p><i>PART #:</i> <b>WAND-7/8" ASSY</b></p>	<b>\$104.00</b>			

**ARMADILLO - Accessories**

COMPONENTS:			COMPONENTS:		
Photo	Description	Price	Photo	Description	Price
	CRUMB BASKET for ARM 60, 90, & 120. with removable screen.. Stainless Steel <i>PART #:</i> <a href="#">CrumbBasket Assembly</a>	<b>\$119.50</b>		REPLACEMENT SCREEN for Crumb Basket <i>PART #:</i> <a href="#">X-CrumbScreen</a>	<b>\$36.95</b>
	<b>Two Piece Lid for ARM-90</b> Stainless Steel - <i>PART #:</i> <a href="#">Lid90</a>	<b>\$129.00</b>		<b>Two Piece Lid for ARM-120</b> Stainless Steel - <i>PART #:</i> <a href="#">Lid 120</a>	<b>\$149.00</b>

